

# Modline<sup>®</sup> 6 Infrared Thermometers

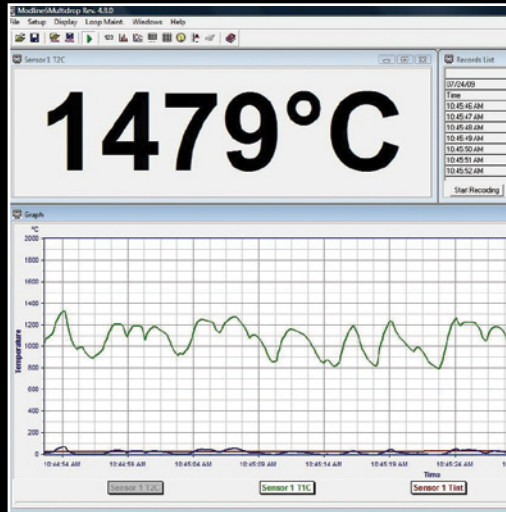
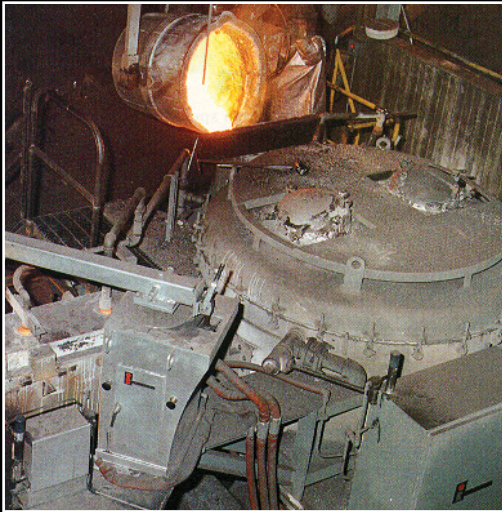

Fiber optic noncontact stand alone  
temperature sensors to serve a  
wide range of applications

## Modline 6 Highlights

- Rugged fiber optic measurement systems
- External user interface provides access to sensor settings and temperature indication from bright LED display
- Several models: 62 Series, 6G Series, 6R Series (Operates in 2 color mode or ratio mode)
- 62 and 6G series include background compensation capabilities
- Modline 6 infrared thermometers permit measurement of targets in harsh industrial environments that are otherwise inaccessible by non-fiber optic thermometers
- Fiber cable rated to 315°C (600°F) available on selected models
- Simultaneous analog and digital outputs

Modline 6 fiber optic infrared thermometers consist of a rugged fiber optic cable, plus re-imaging lens. The assembly is connected to an electronics housing containing the detector, processing electronics, brightly lit LED user interface/display, and termination connections for field wiring.

Modline 6 infrared thermometers maintain high accuracy over the ambient operating temperature range from 0° to 60°C (32° to 140°F) for the electronics housing.

The fixed focus re-imaging lens consists of a small stainless steel cylindrical housing and lens assembly. The re-imaging lens accommodates an air-purge accessory to prevent lens contamination and the fiber optic cable is protected by metal armor. The assembly accommodates a small bend radius for threading through tight spaces. The optional high temperature sensing head/cable option extends the temperature range to 315°C (600°F).

The 62-1610 sensor, specifically designed with customized accessories for measuring glass temperature from 750° to 1675°C (1382° to 3047°F), permits measurement of melter, refiner, regenerator, and forehearth temperatures.

### Alarms:

- Programmable relay output (dual-temperature setpoints or “fail-safe”)
- Unique attenuation alarm for 6R models (attenuation measurement US Patent No. 5,815,410)

### Communications:

- Bi-directional RS485 communications
- Supports up to 32 Modline 6 Series sensors on a multipoint network
- Modline 6 Multidrop Support Software (operates under Windows NT4, Windows 2000, XP)
- Field Calibration Software

## Sensor Specifications

### Performance

#### 62 Series

Spectral Range	1.0µm (Si detector)
Accuracy	±(0.3% Tmeas +2°C); Tmeas in °C ± 3°C for 62-1610
Response Time	10 ms
Emissivity	0.10–1.00 in .01 increments (single color mode)
Repeatability	±1°C
Signal Processing	Peak Hold, Valley Hold, Averaging (all models)
Temperature Resolution	±0.05°C (±0.1°F)

#### 6G Series

Spectral Range	1.6µm (InGaAs detector)
Accuracy	±(0.3% Tmeas +2°C); Tmeas in °C
Response Time	10ms
Emissivity	0.10–1.00 in .01 increments
Repeatability	±1°C
Signal Processing	Peak Hold, Valley Hold, Averaging (all models)
Temperature Resolution	±0.05°C (±0.1°F)

#### 6R Series (Ratio)

Spectral Range	1.0µm nominal (Si/Si detector)
Accuracy	±(0.3% Tmeas +2°C); Tmeas in °C (no attenuation) up to 95% attenuation ± (1% Tmeas +2°C) for 6R-1120 and 6R-1540 up to 95% attenuation ± (1.3% Tmeas +2°C) for 6R-2565
Response Time	10ms
Emissivity	0.10–1.00 in .01 increments (Single Color Mode)
E-slope Range	0.85–1.150 in 0.001 increments (Ratio Mode)
Repeatability	±1°C
Signal Processing	Peak Hold, Averaging (all models)
Temperature Resolution	±1°C (±2°F)

### Outputs

Analog Output (scalable)	0/4–20 mA
Digital Output	RS-485, 2 wire/4 wire, networkable to 32 sensors
Relay Output	Contacts max. 48 V, 300 mA, response time < 2 msec, (software programmable)
Power Requirements	24 VDC, 500 mA, ±20% Compliance CE low voltage directive; EN 61326

### Physical/Environmental

Environmental Rating	NEMA 4, IEC 529, IP65 (Does not apply to the high temperature fiber optic cable option)
Weight	
Electronics Housing	0.75 kg (27 oz)
Re-imaging Lens	0.10 kg (3 oz)
Humidity	10 to 95% non-condensing
Vibration	(Electronics Housing) MIL-STD-810D IEC 68-2-6
Shock	(Electronics Housing) MIL-STD-810D IEC 68-2-27

### Product Compliance

EMC	EN61326-1
Safety	EN61010-1

### Operating Ambient Temperature

Electronic housing	0 to 60°C (32 to 140°F) -20 to 70°C (-4 to 158°F) Storage Temperature
Fiber optic cable and Re-imaging lens	0° to 200°C (32° to 392°F) Standard temperature rating 0° to 315°C (32° to 600°F) High-temperature option
Fiber optic cable protection	Rated to 200°C; stainless steel armor; Viton coating, rubber “boot”, and NEMA-4 (not available on high temperature cable); plus provision for conduit to protect fiber cable

## 62 and 6G User Interface

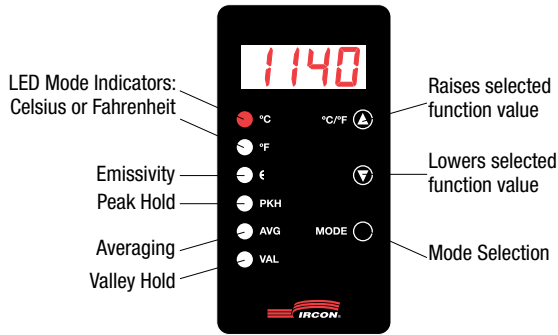

## 6R User Interface

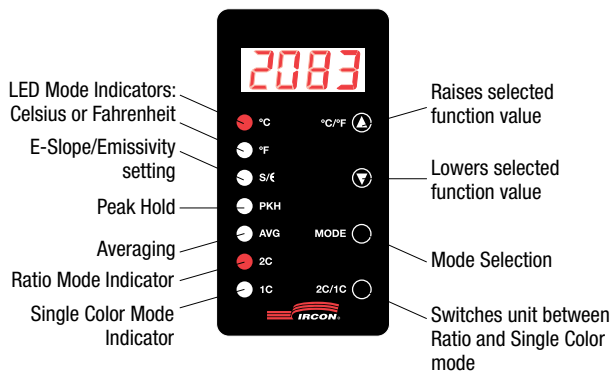

## Physical Dimensions

### Electronics Housing

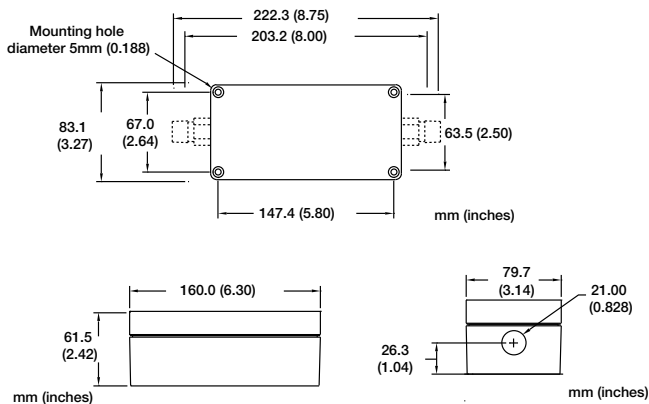

### Re-imaging Lens

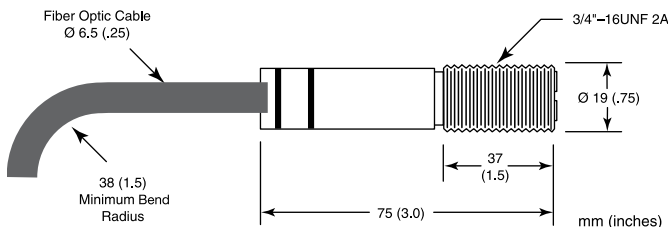

## Accessories



### MB-6 Adjustable Mounting Bracket

Adjustable mounting bracket for Modline 6 re-imaging lens



### AP-6 Air Purge Collar

Air purge collar and stainless steel sighting-tube, 152mm (6 in) long, 25mm (1 in) diameter

- RA-6** Right angle mirror
- AL-6** Aiming-light (battery powered) for fiber optic front end.
- PW-6** Sapphire protective window mounted in stainless steel bezel
- EE3-6** High temperature fiber-optic housing with air-knife purge and sapphire protective window, 3M air/protection hose. For extreme environments.  
Ambient temperature  $\leq 450^{\circ}\text{C}$  ( $842^{\circ}\text{F}$ )
- EE6-6** High temperature fiber-optic housing with air-knife purge and sapphire protective window, 6M air/protection hose. For extreme environments.  
Ambient temperature  $\leq 450^{\circ}\text{C}$  ( $842^{\circ}\text{F}$ )
- POI-6** Power supply (24VDC, 110/220VAC input) & terminal block mounted in a NEMA-4 (IP65) enclosure
- PS-6** 24 VDC 1.1 A switching power supply (110/220VAC input)
- TSP-6** Spare terminal block accessory
- TSPE-6** Spare terminal block in a NEMA-4 enclosure
- TSIC-6** DB25 to terminal strip interface converter, recommended for direct wiring between a serial interface and the terminal block
- PS4851-6** XXX485CVT with 110VAC power adapter
- PS4852-6** XXX485CVT with 220VAC power adapter
- 485-6** DB25 to DB25 interface converter
- USB-6** USB to serial COM port converter

### Glass Tank Mounting Accessory

Consists of RAM-6, RMA-6, and ST12-6 accessories, as shown

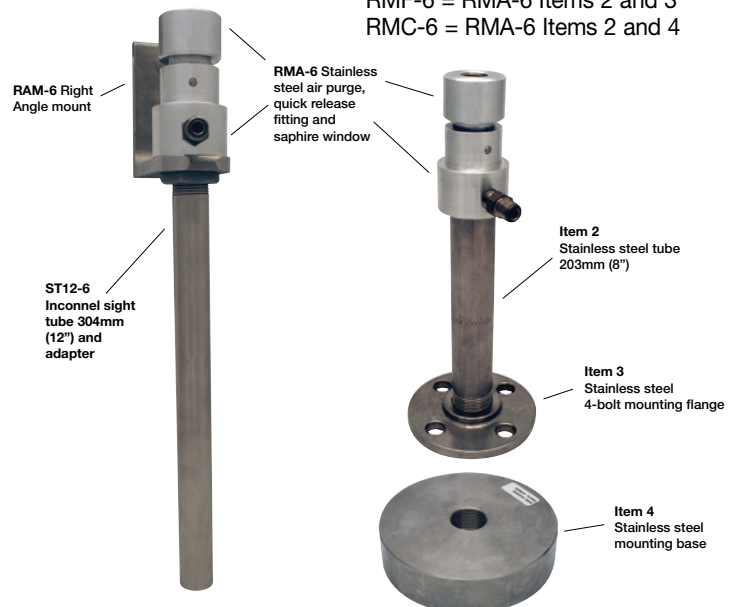

### Rooftop Mounting/Purging

Flexible accessory selections allow you to pick and choose the accessories you need.

RMAP-6 = RMA-6 Item 2

RMF-6 = RMA-6 Items 2 and 3

RMC-6 = RMA-6 Items 2 and 4

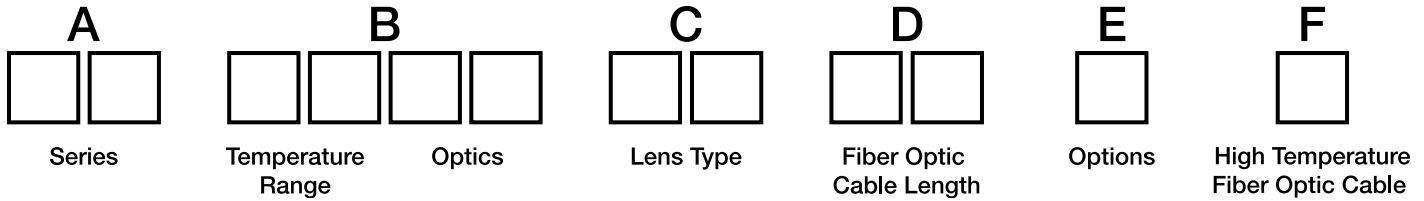

Block A & B	Temperature Range	Spectral Range	Optical Resolution	Block C	Fiber Optic Cable Length	Options	High Temperature Fiber Optic Cable
				Lens type and spot size at focus position (one lens/sensor)			
62-0902	475-900°C (752-1652°F)	1 μm	D/20	<b>2D Lens</b> 76mm (3") @1524mm (60")	<b>2E Lens</b> 4mm (0.17") @102mm (4")	<b>2F Lens</b> 15mm (0.6") @305mm (12")	
62-1610	750-1675°C (1382-3047°F)	1 μm	D/100	16mm (0.62") @1524mm (60")	Not Available	Not Available	
62-1910	800-1900°C (1472-3452°F)	1 μm	D/100	16mm (0.62") @1524mm (60")	1mm (0.04") @102mm (4")	2.8mm (0.11") @305mm (12")	
62-3010	1200-3000°C (2192-5432°F)	1 μm	D/100	16mm (0.62") @1524mm (60")	1mm (0.04") @102mm (4")	2.8mm (0.11") @305mm (12")	
6G-0820	250-800°C (482-1472°F)	1.6 μm	D/20	<b>GA Lens</b> 76mm (3") @1524mm (60")	<b>GB Lens</b> 4mm (0.17") @102mm (4")	<b>GC Lens</b> 15mm (0.6") @305mm (12")	
6G-1740	400-1700°C (752-3092°F)	1.6 μm	D/40	38mm (1.5") @1524mm (60")	2.5mm (0.1") @102mm (4")	7mm (0.26") @305mm (12")	
6R-1120	500-1100°C (932-2012°F)	Ratio	D/20	<b>RD Lens</b> 83mm (3.3") @1524mm (60")	<b>RE Lens</b> 5mm (0.2") @102mm (4")	<b>RF Lens</b> 15mm (0.6") @305mm (12")	
6R-1540	700-1500°C (1292-2732°F)	Ratio	D/40	44mm (1.7") @1524mm (60")	3mm (0.1") @102mm (4")	8mm (0.3") @305mm (12")	
6R-2565	1000-2500°C (1832-4532°F)	Ratio	D/65	27mm (1.05") @1524mm (60")	1.6mm (0.06") @102mm (4")	5mm (0.18") @305mm (12")	

**Factory-Installed Sensor Options**

**Block D** Fiber Optic Cable Length (must be selected at the time of placement)

- 01 1 meter (> 3 ft.) length fiber cable with connectors
- 03 3 meter (>10 ft.) length fiber cable with connectors
- 06 6 meter (> 20 ft.) length fiber cable with connectors
- 10 10 meter (> 33 ft.) length fiber cable with connectors
- 22 22 meter (> 72 ft.) length fiber cable with connectors\*

\* For use with all 6R and 62-1610 sensors only. Not available with other models  
Quote nominal 6 weeks delivery time for 1m, 6m, 10m and 22m fiber-cable lengths

**Block E** Options (must be selected at the time of order)

- 0 None

**Block F** High Temp. Fiber Cable & Lens (must be specified at the time of placement)

- 0 Standard cable option selected
- 1 High-temperature fiber optic cable and re-imaging lens rated to 315°C (600°F) ambient temperature\*\*

\*\* Quote nominal 6 weeks delivery time for high temperature cable

**Primary Applications**

**62 Primary Applications**  
High Temperature Processes:  
Metal forging, annealing, hardening foundries and incandescent processes

**6G Primary Applications**  
Mid to High Temperature Processes:  
Ferrous and non-ferrous metal treating

**6R Primary Applications**  
Difficult High Temperature Processes:  
Molten metals, small wires, small rods, vacuum furnaces and kilns

**The Worldwide Leader in Noncontact Temperature Measurement**

**IRCON, Inc.**  
Worldwide Headquarters  
Santa Cruz, CA USA  
Tel: 1 800 227 8074 (USA and Canada, only)  
1 831 458 3900  
info@ircon.com

**European Headquarters**  
Berlin, Germany United Kingdom  
Tel: 49 30 4 78 00 80 Tel: +44 1908 630 800

**China Headquarters**  
Beijing, China  
Tel: 8610 6438 4691

To find an IRCON office near you, please visit [www.ircon.com](http://www.ircon.com)

**Worldwide Service**

IRCON offers services, including repair and calibration.  
For more information, contact your local office or e-mail info@ircon.com

[www.ircon.com](http://www.ircon.com)



Raytek is an ISO 9001 certified company